

# High-precision and efficient manufacturing

Customized wire solutions

## **Our ambition:** **Your partner for excellence**

As skilled **specialist for wire technology**, we offer high-precision and efficient manufacturing **„Made in Germany“**.

With our professional staff we convince with high quality products, perfect service and unconditional reliability.

We build long-term cooperation with our suppliers and partner companies, characterized by fairness and mutual trust.

**Always with the goal in mind: long-term satisfaction of our customers with the optimal wire solution.**

Let's achieve more together.

# MEETING ALL REQUIREMENTS

To help our customers achieve their goals, we have been constantly developing for 60+ years.



**250+**

qualified employees at 3 locations

**31**

welding machines in production

**30.000 m<sup>2</sup>**

production area

**30.000+**

tons of wire processed per year

**55+ Mio €**

Sales (2021)

**1959**

Deutenberg was founded

**1962**

WDM was founded

**1993**

Foundation of Midrahtec in Leisnig (Saxony)

**2008**

WDM: Entry into 3-dimensional production

**2014**

First-time handling of major projects for online retailers

**2019**

Expansion through acquisition of Midrahtec

**2021**

Merger of WDM and Deutenberg

**today**

With 31 CNC welding machines and three production sites, WDM Deutenberg is the largest wire mesh manufacturer in Europe

# A flexible team that you can always rely on



## Location Wolfshagen

Putlitzer Straße 8  
16928 Gross Pankow  
Germany



## Location Ense

Auf den Geeren 22-24  
59469 Ense  
Germany



## Location Leisnig

Gorschmitzer Weg 2c  
04703 Leisnig  
Germany



# Sustainability

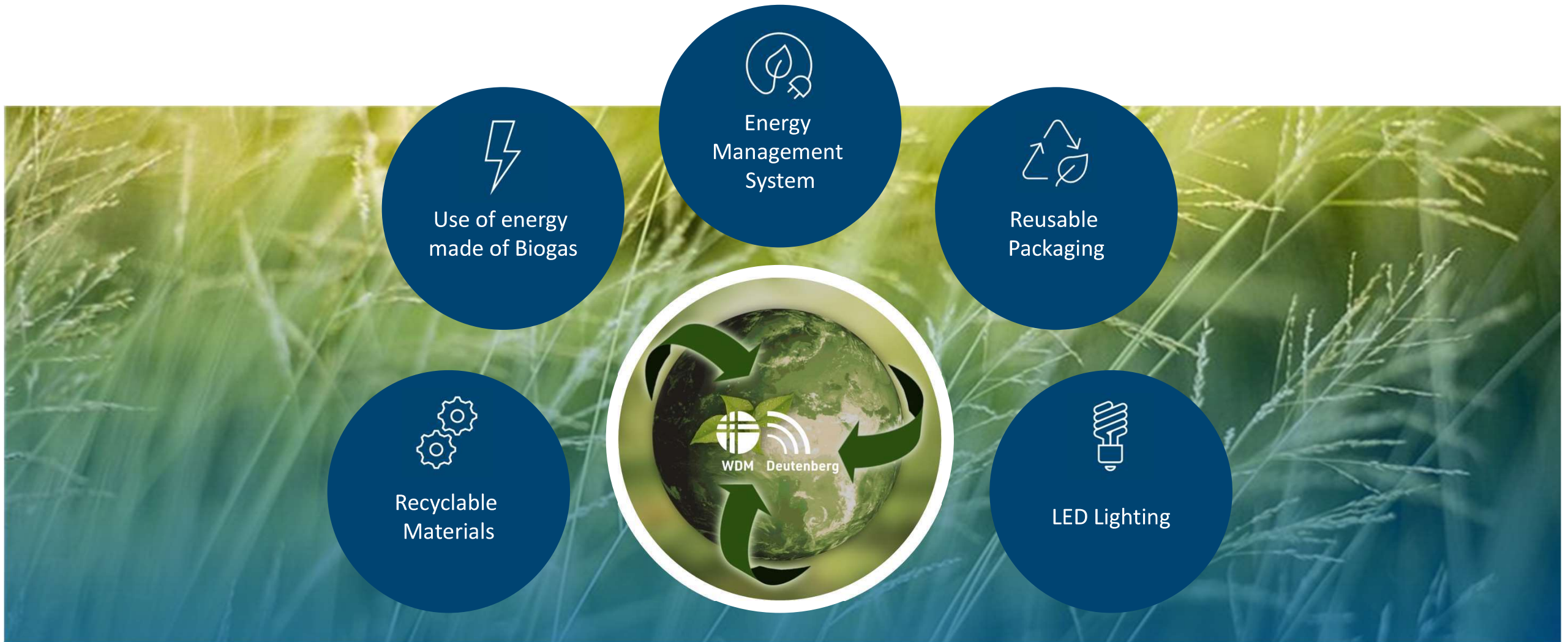

VALUE // WE HAVE THE OPTIONS – YOU HAVE THE CHOICE

# The right solution for all purposes: Our modular product portfolio



## PRODUCT TYPES

Industry and welded mesh

Wire baskets

Complete pull-out systems

Custom-made products

Grid systems

partition walls, frames, reinforcement, cages,  
mats, shelf grids, Stainless Steel

Gabion solutions

fences, baskets, noise protection

## MATERIALS

Raw / bare wires

Galvanized wires

Aluminium galvanized wires

Stainless Steel wires

## MATERIAL STRENGTHS

The diameter of the wires ranges from 1.6 up to 12 mm

## FINISHING & ASSEMBLY

Surface finishing – coating - galvanizing  
and assembly of components

# Our core industries

Our products are manufactured using modern machines **with the highest accuracy and care.**

Our machinery includes CNC bending and CNC spot welding machines, as well as punching and other high-end machines.

We produce with an efficient usage of tooling and **therefore process wires effectively and economically** into complex technical wire articles.

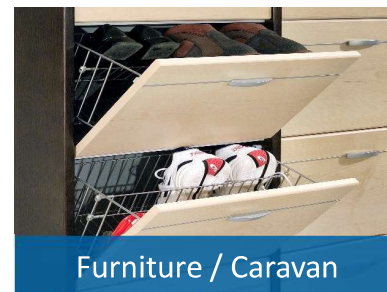

VALIDATION // THE RESULTS SPEAK FOR THEMSELVES



# Highest customer satisfaction in all industries and long-term trust are our hallmarks



Throughout the project, WDM-Deutenberg was always extremely competent and reliable.

Project Manager Logistics Center



We were particularly impressed by the professional advice and the solution, tailored to our needs. The project was consistently positive.

Purchasing Manager Warehouse & Logistics



# Project Support

## SCOPE

From the customer's request to the best-practice solution



### Engineering

Project support for the customer's request; finding the best-practice solution



### Offer

After finding the best possible solution, an detailed offer, including a drawing, is prepared



### Sampling

Possible sampling; creation of a near-production-ready sample for serial production



### Order Placement

Possible order placement after negotiation



### Reconditioning

Constructive preparation for production with feedback and final approval of the customer.

Preparation of all complete drawings, based on the offer and final samples, for serial production



### Delivery

Just-in-time delivery; regular coordination with the project- or site manager to ensure a smooth progress

# Your competent partner, also for the implementation of large projects

## REFERENCE EXAMPLE

Distribution center of a sporting goods manufacturer in Belgium

joint grid floor development with client

start  
2015

project in  
6 stages

completion  
2023

152,000 grid shelves per stage

SILO construction →  
from inside to outside

special use  
of materials



# Your competent partner, also for the implementation of large projects

## REFERENCE EXAMPLE

Distribution warehouse of a large online retailer

most important: occupational safety on all parts  
→ use of our SAFETY EDGE products

28,000 grid shelves

15,000 cross divider

duration 8 weeks - delivery just in time

special depth of  
the grid shelves

cross divider with  
flue-space spacer grids

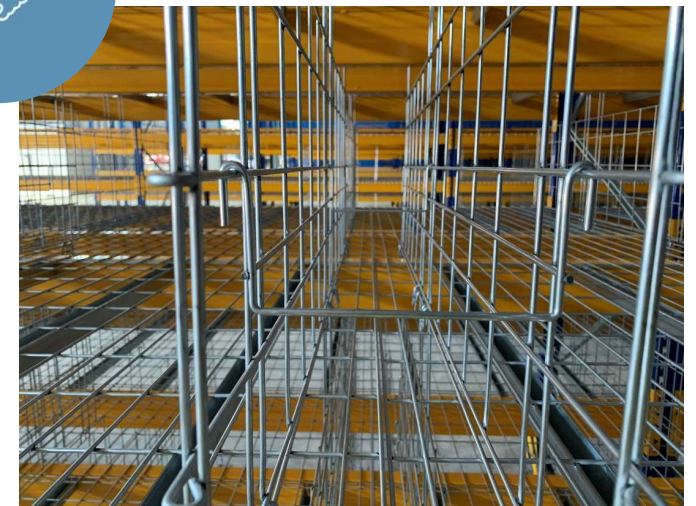
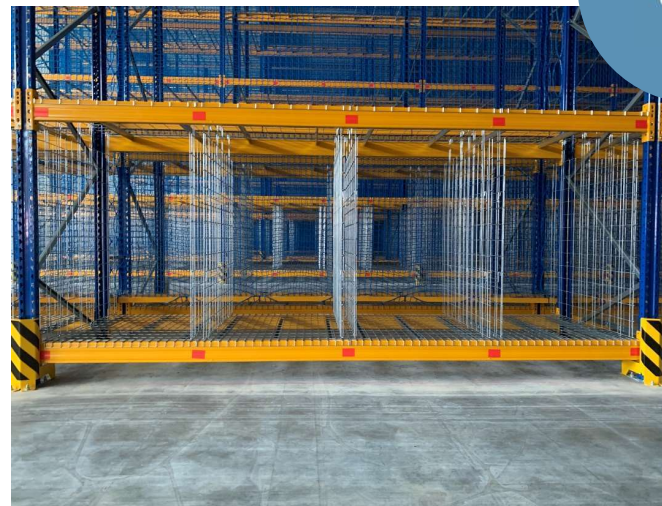
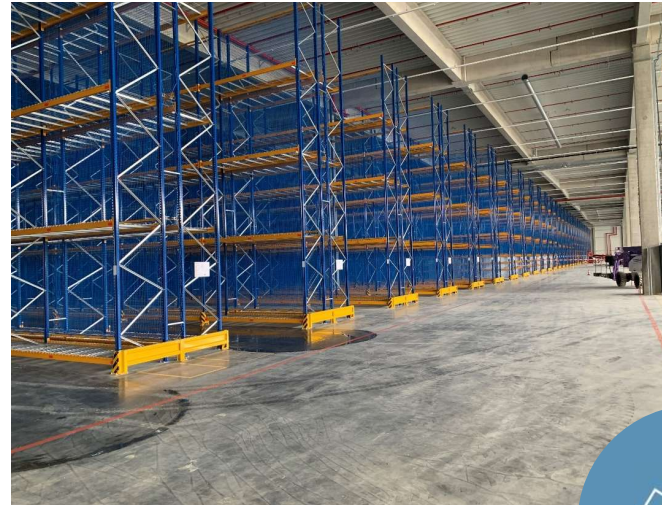

## DEBION® D-FLEX grid floor variants

### Grid floor variants:

- with flat iron
- for use in lowered crossheads → water fall inside
- with U- or V-profile
- front and rear beveled or upturned
- with SAFETY EDGE at the front for optimal work protection

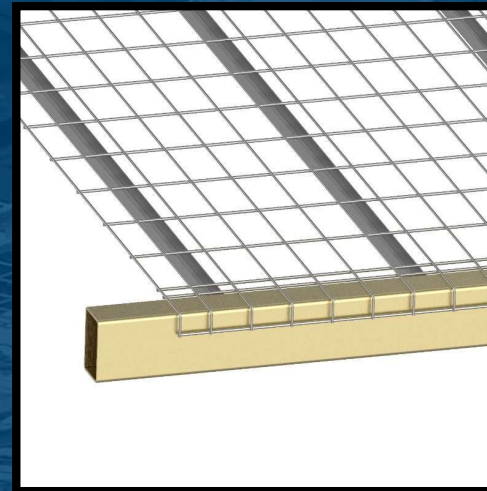

# DEBION® D-FLEX lengthwise and crosswise divider variants

## Lengthwise and crosswise dividers:

- to hook and fix at the bottom of the floor
- rotated hanging for optimal product protection
- free standing for clamping in the floor
- front edge with SAFETY EDGE for optimal work safety

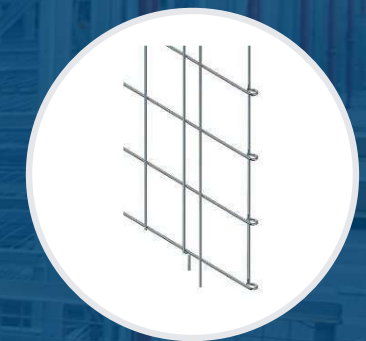
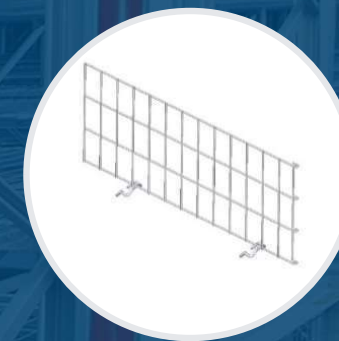
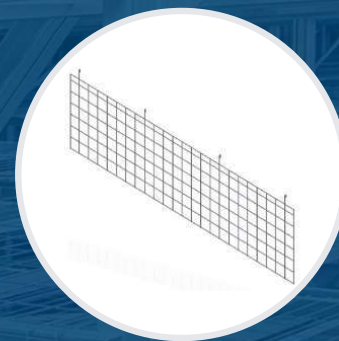
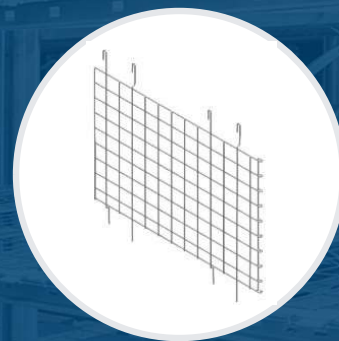
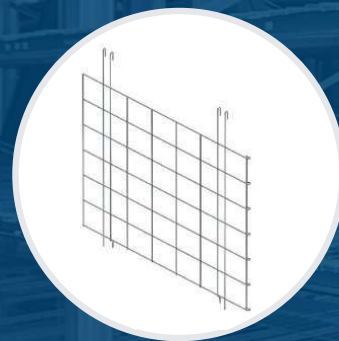
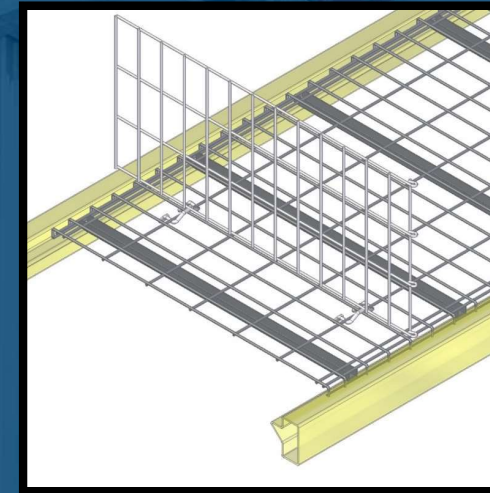
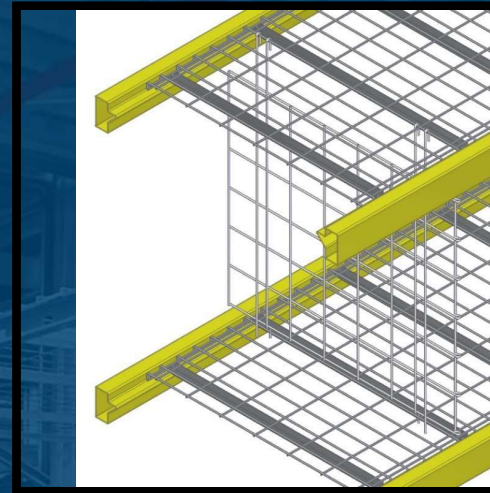

EXPERTISE // MORE THAN JUST STANDARD

## DEBION® D-FLEX – SAFETY EDGE



### SAFETY EDGE Edge finish:

- For optimal work safety
- All ends rounded
- No risk of injury during handling

For optimal work safety: SAFETY EDGE

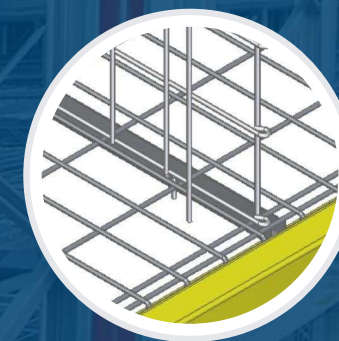
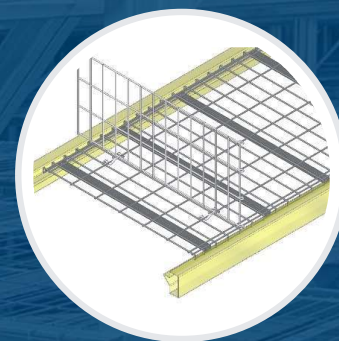
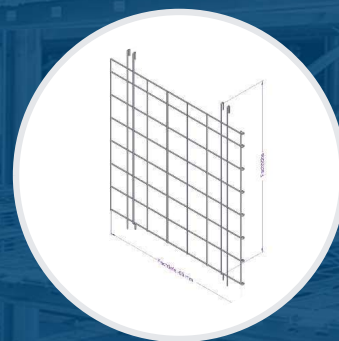
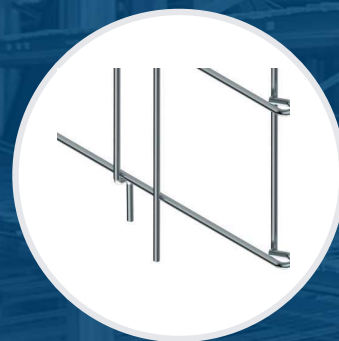
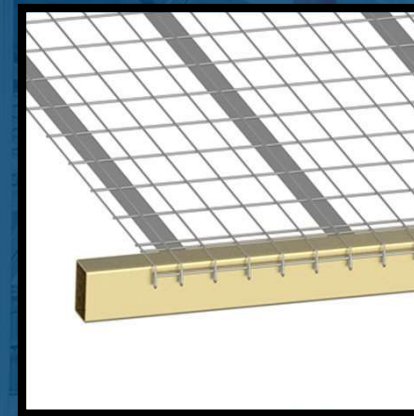
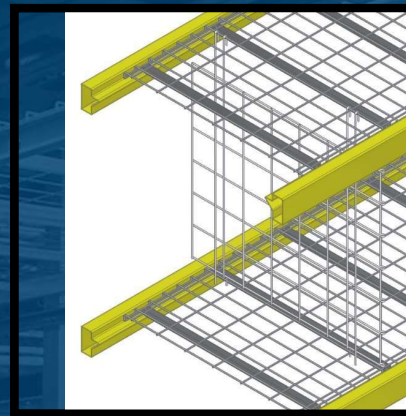

# Our comprehensive range is unique on the market in terms of vertical integration and performance

Since our foundation, we have become the **largest wire mesh manufacturer in Europe**. Over 60 years of experience and dedication have sharpened our eye for the diverse requirements of our customers.

As your competent partner, we offer comprehensive solutions that make it easier than ever to find **the optimal wire solution for your needs**.

## KNOW HOW

Experience in the management of large projects

## EFFICIENT

Processing of large orders within the desired time frame, including short delivery times

## RELIABLE

Personal support and service

## INNOVATION

Own engineering, including intellectual property rights such as utility model protection/patent

## CUSTOMISATION

Customized production, starting from a batch size of 1

## NETWORK

Benefits from synergy effects through our partner and company mergers